

December 98-January 99

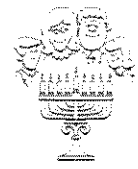

5627 University Way NE • Seattle • 206-527-4822 • http://www.rodcycle.com

THE NEWSLETTER OF CYCLING VALUES!



WE'RE HAVIN' A PARTY!! AND YOU'RE INVITED!

Thursday Dec 17 from 5-8PM

Some people celebrate silver anniversaries and golden birthdays. Well, R+E is celebrating a **TITANIUM CHRISTMAS.**

Mongoose bicycles has recently been purchased by Brunswick Sporting Goods. Yep, bowling balls, and pool tables and even outboard motors for boats. What interest could they possibly have in bicycles and what does that mean for the consumer? It means that it is now a bicycle company with a lot of capital, new ideas and energy. They are excited to try new things.

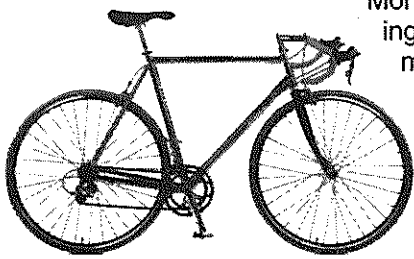

One of the first things that Mongoose bicycles did was invest in the Titanium bike market. They purchased all of the

shop time from the company Sandvik who has been building most of the American Ti frames, under various builder's names. They are producing the highest quality Ti frames (road, mountain and triathlon) at incredibly affordable prices. Imagine a Ti road frame for \$1250 or a complete Ultegra equipped titanium bike for only \$2599!! And we are going to celebrate by throwing a Holiday Party, sponsored by Mongoose.

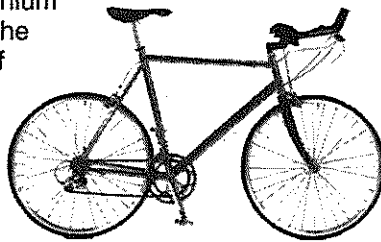

WHAT'S INSIDE

Aluminum Rodriguez tandem	Pg. 2
Ton-O-Fun tandem ride	Pg. 2
Women's bicycle camp	Pg. 3
1999 Kona bikes	Pg. 3
Gore-tex sox	Pg. 3
Fun gift ideas	Pg. 4
Light up the night	Pg. 6
Rollers & Trainers	Pg. 8

WINTER HOURS BEGINNING SEPT. 1ST

MONDAY - CLOSED
12 - 6 Tuesday - Friday
10 - 5 Saturday
12 - 4 Sunday

*By Appointment Anytime!!
Just call during business
hours to set one up.*

Win a Ti frame, or this
mountain bike FREE!!

WIN A FREE BIKE!!

Santa Claus is coming a little early for 2 very lucky people! Please join us on Thursday Dec 17 from 5-8PM. We are celebrating by offering **EVERYTHING IN THE STORE FOR 10% OFF** during those 3 hours. And if you choose to purchase a titanium Mongoose frame or bike, that night, we'll give you the pro deal of 20% off. We'll have representatives from Mongoose on hand to answer questions and you can test ride the bikes. We'll have drinks and snacks and door prizes.

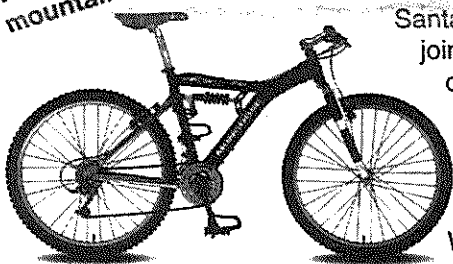

We are also going to give away a Titanium Mongoose frame (\$1250 value) and a complete Mongoose full suspension aluminum mountain bike with a Rock Shox fork (\$1050 value), from a random drawing held that night. Be sure to be here December 17th so we can enter you in the drawing.

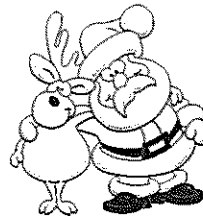

**Thursday Dec 17
from 5-8PM**
Mark it on your calendar

CALL TODAY AND SET UP A TIME TO TOUR OUR FRAME BUILDING AND PAINTING FACILITY! IT'S FREE!

RE Joe Schmo?

Joe Blow has become our favorite floor pump. With a twin head, it works easily on either presta or schrader valves. It has a metal body and replaceable hose so it should last nearly forever. Reg \$55

Gift Price: only \$42.99

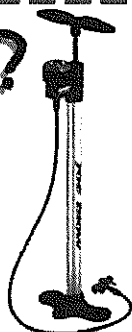

Offer good with coupon only. No cash value. Expires Jan. 10, 1999.

RE You can see right through this deal!!

These clear raincoats allow you to show off your wicked jersey. They are clear plastic with vents, just like the real racers wear. Be cool. Reg: \$20

Holiday Special: \$16.99

Offer good with coupon only. No cash value. Expires Jan. 10, 1999.

WIN A FREE TITANIUM FRAME OR A FULL SUSPENSION MOUNTAIN BIKE!!

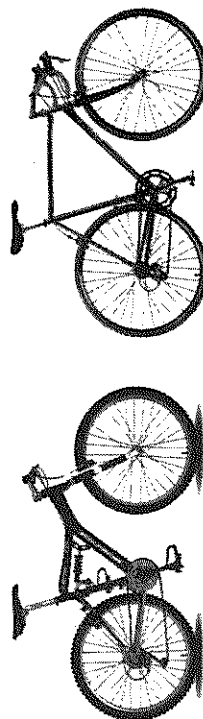

Bring in this coupon on December 17th between 5 & 8 pm. We will be drawing for the bikes that evening. If no mailing label is attached, please write in your name, address and phone number below.

Bulk Rate
U.S. Postage Paid
Seattle WA.
Permit No. 12977

Coupon must be received before 8pm Dec. 17, 1998. No purchase necessary to win

Holiday Specials! 1999 bikes are in stock now! 90-day Same as cash (O.A.C.) on bikes!

BIG, FAT, ALUMINUM TUBES!

The return of the Rodriguez Aluminum tandem!

Back in 1989, Rodriguez was one of the first companies to build both steel and aluminum tandems. Back then, steel tandems were much heavier, and more expensive than they are now, and aluminum was a way to save some weight at that same price. As steel evolved though, it became much lighter, and even more economical. Building techniques evolved, and with the introduction of tig-welding, building with steel became very affordable. By 1993, it was possible for us to build a steel tandem that was just as light as our aluminum tandem, and less expensive, so the aluminum Rodriguez was discontinued.

Over the years, there have been some die-hard aluminum fans that long for the old aluminum Rodriguez tandem. Well, we decided to bring back an aluminum tandem for 1999! They will be built custom for each couple. There are some differences in this tandem as compared to the old Rodriguez aluminum. It only makes sense to make an aluminum tandem if it can be lighter than a steel tandem at a comparable price.

The 1999 aluminum tandem is made of lighter, yet stiffer tubing than its predecessor. The tubing has a larger diameter, and thinner wall. The ride of a tandem like this one isn't for everyone.

The ride on this tandem is perfect for the couple who likes to ride light, stiff, aluminum road bikes. The weight savings are pretty significant. In comparison to our basic steel frame, the 1999 Aluminum weighs in 3.5 lbs less. The Aluminum tandems will sell for \$1999 (introductory price) for a frame/fork in a single color paint job, or as little as \$2999 for a complete tandem ready to ride. That's less than the production models of 1989 were introduced at!

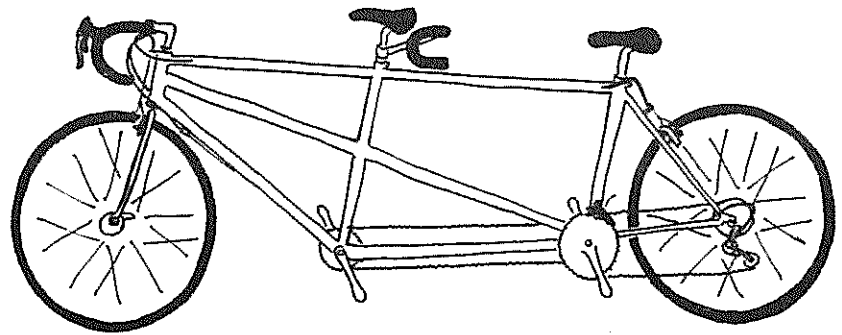

We've got one at the shop available for test rides. Come in and try it out today!



WANNA HAVE A TON - O - FUN??!!

Heavy Metal. Let's go. How heavy a ride can we have? Meet at R+E at 10AM on Sat Jan 9 for a short but heavy ride. We'll ride from R+E to a truck scale (transfer station? sand and gravel yard?) and weigh the group. Let's see how heavy we can get. We'll give prizes to the heaviest single and tandem (load those panniers with bricks and eat an extra cinnamon roll!), and we'll make the lightest riders buy the coffee (only kidding). Come ready for fun and laughs and a very easy ride. Children encouraged!!!

CLIP AND SAVE

RE Too hot for tights?

Lots of people like knickers if they find they are too hot in tights but too cold in shorts. Some people like them because they are sensitive about their thighs or they want to show off their tattooed calves! Whatever the reason, we have the garb. Giordana knickers have an antibacterial chamois and a great fit. Reg: \$60

Holiday Special: \$47.99

Offer good with coupon only. No cash value. Expires Jan.10, 1999.



RE Zippity do da!

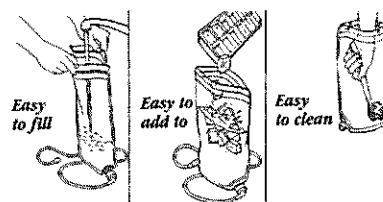

Is it a hassle to fill you water bag because it has a little opening and spills out when you try to put the cap back on? Cascade Designs to the rescue. This food quality plastic leaves no taste and the entire end of the bag opens up

like a zip lock bag!

70 oz bag for only \$22.99

Offer good with coupon only. No cash value. Expires Jan.10, 1999.

RE For Roadies Only

The Be Bop clipless pedals will lighten any bike and be a pal to your knees. With about 30 degrees of flotation they allow your knee to express its natural movement. You'll see why they get the highest rating in all the cycling magazines. Reg: \$149.99

Holiday Special: \$109.99

Offer good with coupon only. No cash value. Expires Jan.10, 1999.

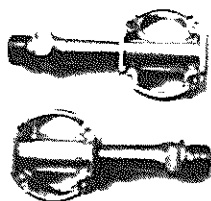

RE Matchey Poo!



Are you looking for matching jerseys? We have some stylin' Bellwether long sleeve jerseys for both men and women. The "tangerine" jerseys are a very contemporary color as well as visible for safety. Reg: \$50

Tandem Special 2 for \$64.99

Offer good with coupon only. No cash value. Expires Jan.10, 1999.

ESTELLE GRAY & RODRIGUEZ BICYCLES ARE CONDUCTING A WOMEN'S CYCLING CAMP!!!!

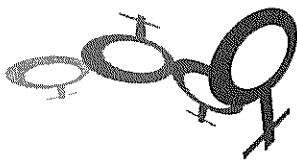

And the timing is perfect...you can buy it for your favorite woman (women??) for the holidays, tell all of your friends to chip in and buy it for you, or you can sign up early and save \$25.

This weekend camp will be held June 4-6 at Mountain Springs Lodge outside of Leavenworth, WA. The seminars and instruction will be geared towards women who want to ride their bikes more efficiently. We'll focus on understanding your gears so that you can ride faster and further more easily. We'll concentrate on making the hills feel easier and help you improve your bike handling skills. We'll cover topics such as efficient gear shifting, injury prevention, proper bicycle fitting, training, basic roadside repairs, equipment and clothing. You'll have an opportunity to try clipless pedals and work with a cadence computer.

We welcome riders of all ages and abilities. The material is designed for the woman who wants to get a better understanding of her bike as well as those who are going to ride from Seattle to Portland and want to do it more easily and efficiently.

Instructors will include:

- Estelle Gray, owner of R+E Cycles, world record holder
- Julie Johnson-2nd Place finisher Race Across America, Physical Therapist
- Anna Schwartz- women's 24 hour cycling record holder, Nurse Practitioner
- Betsy King- 5 time Tour de France Veteran, Nurse Practitioner

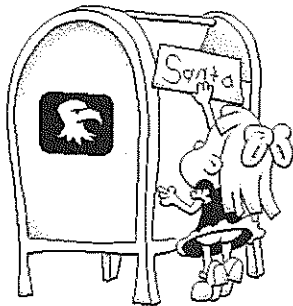

Cost of the camp is \$299 and includes
2 nights lodging (single beds, four to a room)
6 meals (Fri dinner thru Sun lunch)
Instruction and all materials
Use of a cycling computer with a cadence function.

To sign up:

Name _____ phone(s) _____

Address _____ city, st. zip _____

Form of Payment:

Check enclosed Credit Card # _____ exp. _____
Type of card: Visa MC Discover

We will send follow up confirmation with detailed information

To receive further information e-mail us at rodtandem@aol.com or leave a message at 206-527-8931 ext:911

GUARANTEED WATERPROOF

SealSkinz® socks keep your feet dry in water mud or snow. Their patented technology keeps 'the wet' out while allowing perspiration to escape. We've seen these on the market for a while but last year a few of the employees started riding with them and now we won't leave home without them. We recommend a thin liner sock underneath them. When we say guaranteed, we mean it. If you are not completely satisfied, you'll get your money back!! **Only \$32.99**

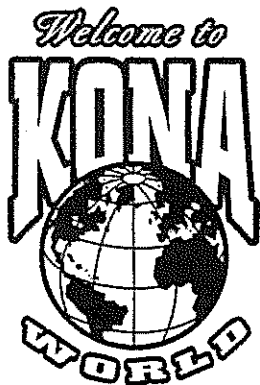

To some people, Kona means Hawaii or coffee. To mountain bikers, Kona means top quality, great value, unique mountain bikes. These bikes are designed by folks who live and ride in the Northwest. They understand the wet, muddy conditions we often expose our bikes to. Better than any other production brand, they properly proportion the reach to the bars to the length of the seat tube.

Kona also makes a great cyclocross bike which can double as a touring or commuting bike. New for 1999 they are offering 2 hybrids. When you take a Kona out for a ride you'll see what a great bike it is. When you pull out your wallet you'll see what a great buy it is.

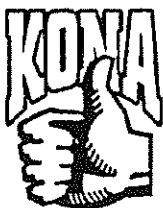

Not quite bulletproof....



But completely windproof. These women's vests are perfect for winter layering or being your main outer garment in the spring. They are fleece lined, have a rear pocket and reflective piping. They are ideal for cycling, skiing or running and you might even wear it to the movies! Reg: \$50

Holiday special: \$39.99

Offer good with coupon only. No cash value. Expires Jan.10, 1999.



WHERE IS YOUR BIKE??

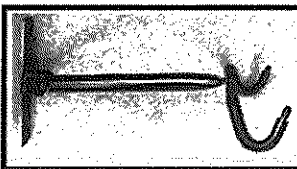

If it is leaning against a wall or you are tripping over it in the middle of your room we have the perfect solution. This wall mounted rack folds flat when it is not in use. It is nice looking and protective so it will not scratch your bike.

Reg. \$15

Holiday Special \$9.99

Offer good with coupon only. No cash value. Expires Jan.10, 1999.



We Kid You Not



We have the coolest kid's cycling jerseys just in time for the holidays. High tech Cool Max fabric, rear pockets, and an eye catching cycling graphic, they are just like mom and dad's. Go ahead, spoil your kid!! Reg: \$30

Holiday Special only: \$24.99

Offer good with coupon only. No cash value. Expires Jan.10, 1999.



Dry Bags for Cyclists??

These new bags are designed to fit inside your existing pannier. Waterproof, with a roll top closure, they make any pannier waterproof without any additional hassle. Insert these into your current bags and your stuff will stay dry throughout any storm. Give them for a gift or pick up a pair for yourself.

Only \$24.99 a pair

Offer good with coupon only. No cash value. Expires Jan.10, 1999.

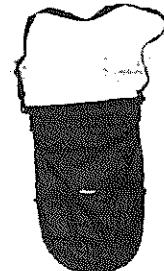

What to put in that stocking??

How about a nifty little blinkin' light that mounts to a helmet or clips on to a backpack or piece of clothing??? It is small enough that you'll still have room to include an orange!! Or you could decorate the whole tree with a bunch of these (see us for a tree decorating discount!) Regularly \$8

Stocking discount only \$4.99

Offer good with coupon only. No cash value. Expires Jan.10, 1999.



Yee Ha	altus,acera x, grip shift	299.99
Hahanna	Acera X, STX, RST shock	329.99
Humu 1 (Cruiser)	Butted Cro-Mo, Mavic X138	359.99
Fire Mtn- rigid	Alivio, STX-RC, Butted Cro-Mo, Shock	399.99
Hoo Ha (Hybrid)	Nexave T300, Mavic T138, Aluminum	449.99
Fire Mtn	Alivio, STX RC, RST shock, Butted Cro-Mo	479.99
Lava Dome	LX, STX RC, DB Cro-Mo, RST-381 shock	549.99
Nu Nu	LX, STX RC, Cyclone, Bomber Z5, Aluminum	639.99
Cinder Cone	Lx, XT, STX RC, Bomber Z5, Aluminum	729.99
Caldera	Lx, XT, Lx, STX RC, Bomber Z4	849.99
Muni Mula	Lx, XT, Lx, LX, X221, Aluminum, Bomber Z4	949.99
Jake the Snake (Cyclocross)	105, STI, Aluminum	1099.99
Pahoehoe	Lx, ST, LX, LX, Easton Aluminum, Bomber Z3	1169.99
Haole 105 (Road Racing)	105, CXP 23, Columbus Megatube	1279.99
Explosiv	Lx, XT, Reynolds 853, Atom Bomb	1349.99
ManoMano	Lx, XT, LX, STX-RC, Full Suspension	1439.99
Kapu (Road Racing)	Ultegra, CXP 23, Columbus Megatube	1589.99
Chute	Lx, XT, Raceface, Full Suspension	1599.99
Kula	XT, XTR, XT, Raceface, Atom Bomb	729.99
Stinky	XT, STX RC, Full Suspension	1799.99
Mokomoko	LX, XT, Full Suspension	1899.99
King Kikapu	XT, XTR, XT, Raceface, Full Suspension	2399.99
Stab	XT, Race Face, Down Hill Racing	2499.99
Stinky Dee-Lux	XTR, Race Face, Full Suspension	2499.99
Hei Hei	XT, XTR, XT, Raceface, Titanium	3199.99
King Kahuna	XTR, Bomber, Easton Aluminum	4199.99

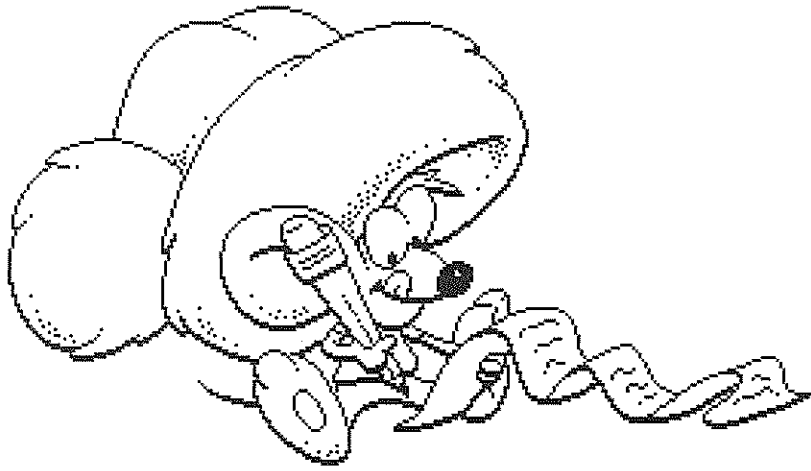

RE Rain Rain Go Away



And if it won't, then at least keep it out of your face with a Giro Helmet Visor. These nifty visors velcro on and off any helmet. Once you try one, you'll wonder how you ever rode without it. Reg:\$15

Rainy Weather Special \$12.99

Offer good with coupon only. No cash value. Expires Jan.10, 1999.

RE Women's Lib Encourages Cycling

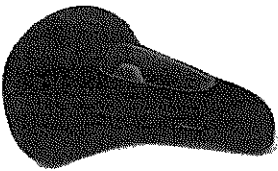

The Terry Women's Liberator Saddle takes care of the pain "that dare not speak its name". Most women get sore from the nose of their saddle rather than the back. This saddle with its cut out will give your "girl parts" the relief you might be looking for. Reg:45

Holiday Special: \$39.99

Offer good with coupon only. No cash value. Expires Jan.10, 1999.

RE Better than Sliced Bread

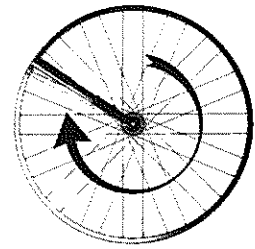

The Speed Lever has revolutionized the art of flat tire changing. This handy lever removes and remounts your tire almost effortlessly. If you remember to ask us, we'll show you how to magically remove your rear wheel in seconds. Reg:\$8

Stocking Stuffer deal: \$6.99

Offer good with coupon only. No cash value. Expires Jan.10, 1999.

RE Coming and Going

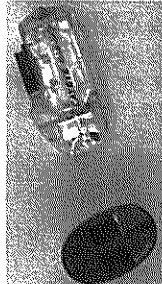

The Cateye light package is the best answer for the cyclist who rides at night but does not want to spend a hundred dollars on a light. The halogen front light sends out light 360 degrees and the blinking tail light is visible for hundreds of yards. Reg:\$30 Get the whole set for:

only \$24.99

Offer good with coupon only. No cash value. Expires Jan.10, 1999.

RE The Perfect Combination

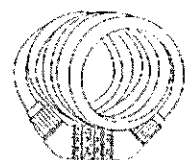

Did you ever forget the combination to your gym locker? What about your bike lock? The nightmare is over. Our Advent bike lock is a coiled cable with an integral resettable combination lock. Pick your own! Perfect for kids or adults. And it even comes with its own bracket. Reg:\$17

Holiday Special:\$14.99

Offer good with coupon only. No cash value. Expires Jan.10, 1999.

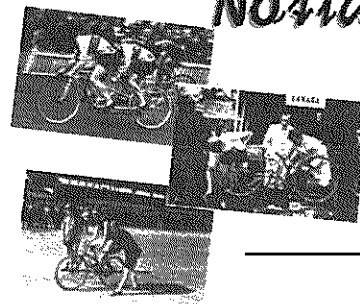

Nostalgia never gets old.

Here's an opportunity to own some historical moments of cycling. You can choose a postcard set of scenes from the 1948 Olympics or an assorted vintage collection. A package of 10 cards sells for **Only \$4.99**

Bare Walls??

Everyone loves bicycle posters. Last year's 2 favorites were The Smokers and The Drinkers, scenes from the Tour de France. This year we'll have those as well as a replica of an old English poster featuring track racing, sponsored by Fry's Cocoa. We'll also have a reprint of a German poster of a well dressed monkey riding a bike-guaranteed to make you smile.



Smokers: \$19.99

Drinkers: \$19.99

Fry's cocoa:\$19.99

Monkey:\$9.99



Better Than a Necktie!

If you want to look good and stand out at the party or the office, hang this bolo around your neck. It is a perfect replica of a crank set. It is also the perfect gift for that hard core bikie.

Only \$24.99

Make Mine A Tall Cold One!



It's a fact. Beer tastes better when you drink it from a really cool glass. Check out the glasses from the Old Guys Who Get Fat in Winter Racing Team. Their special brews are Spare Tire Ale and Portly Guy Porter. Each glass features a cool graphic from cartoonist Patrick O'Grady. Can't decide which one to get? Get one of each...you've got two hands haven't you??

Only \$9.99

NEVER FUSS WITH YOUR WHEEL AGAIN!!

It can be either very confusing or a hassle to deal with your front quick release. With the new safety tabs on forks, you need to unscrew the nut and then be sure you reinstall it to the proper adjustment. You might wish you had another hand or merely didn't have to do this. QUICK NUTS to the rescue! Toss away your adjusting end and install this new cap that has a preset stop. It's aluminum and lightweight, and you'll never have to fuss with your quick release again. Give one to

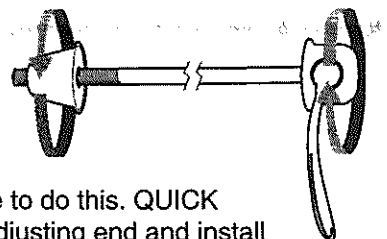

anyone you need to buy a small gift for!!!

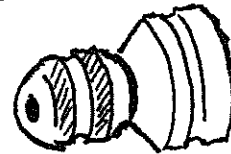

Reg: \$5 Stocking Stuffer Special 2/\$7.99

RE No Bells or Whistles

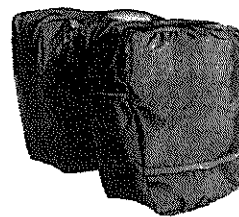

These Jandd Economy panniers do their job. They are built to last but don't have a whole lot of extras.

They include the same mounting system and material as their high end bags but they are just one compartment. Perfect for commuting, day rides or as front panniers. Reg: \$85

End of Year Bargain

Price: \$54.99

Offer good with coupon only. No cash value. Expires Jan.10, 1999.

RE Soft Luggage on Wheels

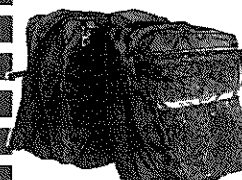

Panniers have been ahead of their time! Much nicer than a backpack these Jandd Mini Mountain panniers even expand to give you a little extra capacity. Easy on, easy off, they are perfect for weekend camping or supported tours. Reg:110

End of Year Bargain

Price:\$79.99

Offer good with coupon only. No cash value. Expires Jan.10, 1999.

PASTA PASTA PASTA

Not plain ordinary pasta but noodles shaped like bicycles. They are guaranteed to be the hit of the potluck or meal as well as draw giggles of appreciation around any Menorah or tree.

Only \$5.99

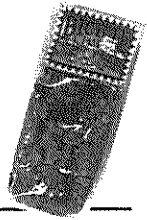

Do you have a living room?

These two books, The English Mechanic 1870 and the Velocipede 1870 are perfect for any coffee table. They are paper bound replicas of two of the hottest cycling books from 129 years ago.

Only \$11.99

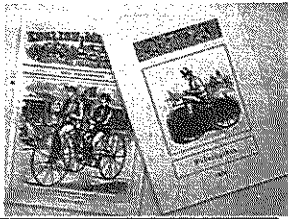

Decorate the Tree

If you are looking for a unique ornament we've got it! Perfect for anyone who rides their bike; it is a triple crank to hang from the tree. Compatible with all shift levers!

Only \$9.99



Oh Baby!!!!

Get that kid started early. It is a baby bib with a gnarly trike with a "Born to Trike" caption. The kid might not thank you but the parents will!

Only \$9.99



The Ultimate Tandem Accessory!!!

Tandem bookends. The picture says it all. (Rip out this ad so your spouse won't see it.)

They are wrought iron and made in the USA. You can't go wrong and it's a gift that won't be duplicated.

One size fits all!!

Only \$49.99

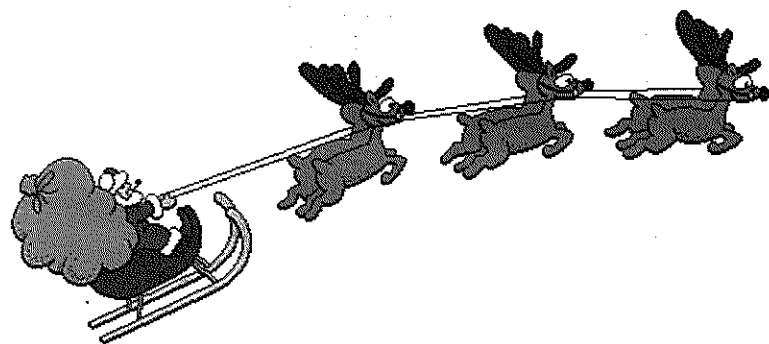
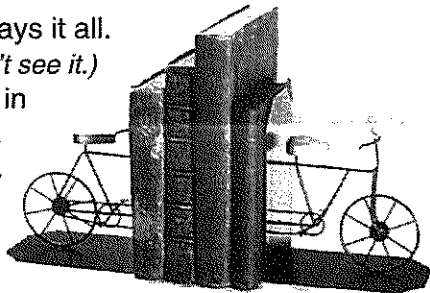

Why not surprise your sweetie with a brand new titanium bike!?

During our Christmas party, you can pick one up on sale for just \$2199!

Includes:

- Mongoose titanium frame
- Profile SC carbon fork
- Shimano 105 Components
 - 9-speed
 - STI shifting
 - Mavic rims
- 3-year wheel warranty

All for just \$2199!



Chicken Little Might Have Been Right

Sometimes it rains so much you might wonder if the sky isn't falling down. If you want to keep your head warm and dry under your helmet we suggest a Waterproof Ultrex Helmet Cover.

These Burley covers are reg:\$13

Holiday Special:\$10.99



Offer good with coupon only. No cash value. Expires Jan.10, 1999.



Disguise Yourself as a Racer

Cycling caps look really cool and the visor helps keep the rain out of your eyes. BUT they also protect your scalp if it is missing its natural protection. Keep yourself from getting helmet stripes on your head! Reg:\$6

Holiday Special:\$2/\$9.99

Hurry! Limited to stock on hand!

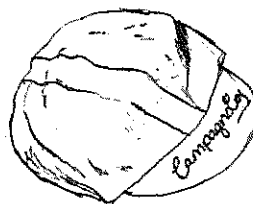

Offer good with coupon only. No cash value. Expires Jan.10, 1999.



Whips and Chains?

How about Clips and Straps instead? Delta toe clips are our favorite because they come in sizes instead of "one size fits all". These fit road, mountain or cross bikes. Set of toe clips and straps reg:\$8

Holiday Special: \$5.99

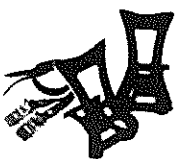

Offer good with coupon only. No cash value. Expires Jan.10, 1999.



No Sweat

Sweatbands are multipurpose. These terry bands easily fit under a helmet or you can wear it running, for basketball or any other time you want to keep sweat out of your eyes. These bands feature cycling team logos. Reg:\$4

Stocking Stuffer Special: 2 for \$6.50



Offer good with coupon only. No cash value. Expires Jan.10, 1999.

Holiday Specials! 1999 bikes are in stock now! 90-day Same as cash (O.A.C.) on bikes!



Stripes Are Out

It's not too cool anymore to have that big muddy strip up your back. Clip on a pair of Zefal fenders and stay dry and warmer. No bolts or tools required, they easily go on and off. Zefal sport fenders for mtn bikes. Reg:\$23



Holiday Special:\$19.99

Offer good with coupon only. No cash value. Expires Jan.10, 1999.



Think Ahead...Get Ahead

It's a proven fact. Aero bars make you go faster. Install some aero handlebars, and shave down your time to Portland or place higher in your next triathlon.

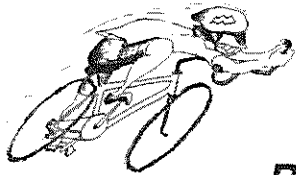

All Profile Aero Bars are 15% off.

Special orders included!

Offer good with coupon only. No cash value. Expires Jan.10, 1999.



Huff and Puff and Blow Your Tire Up

Forget the huffin' and puffin' part and use a zefal SP frame fit pump instead. These pumps will pump up to 120 pounds and fit schraeder or presta valves. Just say no to those tiny pumps that make you work really hard.

Reg :\$15

Holiday Special: \$8.99

Offer good with coupon only. No cash value. Expires Jan.10, 1999.



Doin' time behind bars??

We want you to be comfortable while you are hanging out on your mountain or hybrid handlebars. Install a pair of Advent bar ends and you'll have some additional hand positions as well as gain some efficiency hill climbing. Green or Blue - Reg \$19.99

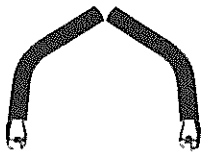

Closeout: \$7.99

Offer good with coupon only. No cash value. Expires Jan.10, 1999.



OUR FAVORITE LIGHT!

The Cygo Lite Night-Explorer is our favorite system for the Seattle commuter. It has dual beams, and a 3-hour rechargeable battery pack. Use this coupon to receive a FREE blinking tail light when you purchase a Cygo Lite Night-Explorer for just \$109.99

FREE IS A VERY GOOD PRICE (\$13 value)

Limited to stock on hand

Offer good with coupon only. No cash value. Expires Jan.10, 1999.



DUAL HEADLIGHT



RECHARGEABLE 6VOLT BATTERY



Cover Your Eyes!

Eye protection is as important in the winter as it is in the summer. We have some clear wrap around cycling glasses that are perfect for riding in the dark or rain. Or if you prefer a yellow lens, we have those too. Reg. \$20



Holiday Special \$9.99

Offer good with coupon only. No cash value. Expires Jan.10, 1999.

Tried and True

Every few years a new company appears on the American market that we feel is here to stay. Sigma Sport is a relatively new name in cycling computers but they have quickly gained our confidence. Their products are reliable, durable and you get a lot of product for the money. We have sold their entire line of bicycle computers for 3 years now, and have had basically no returns or warranties. With a cyclocomputer, that is a big thing to boast! Now they have entered the market with an equally well made heart rate monitor.

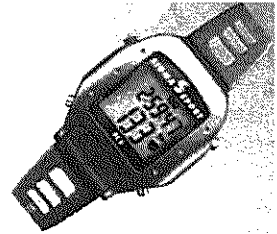

It includes all of the functions of a sports watch plus a heart rate reading and allows you to set a zone with an audible alarm. It also includes a handlebar mount. We are confident that its quality, and features for the dollar, can't be beat. For \$99 it is the best value of its kind. Our Introductory Holiday Special is only \$89. And as an extra holiday gift to you, we'll include a free copy of Sally Edwards' Heart Zone Training with the purchase of this fitness gift.

Sigma also has a new high tech taillight. This innovative light mounts onto any size seatpost with an easy to use ratcheting clamp. You can remove or install it in seconds without requiring the use of any tools or shims. It also allows you to set the light at a variety of angles. It's the best made light we've seen. Only \$12.99

LIGHT UP THE NIGHT!

Our favorite lighting system of all time!

Every year at R&E Cycles, we sell lots & lots of lighting systems to cyclists who ride in the dark. In the winter, it is dark at 5.00 PM. and some people like to have the finest lighting system available.

There are several things that make a lighting system great:

- Brightness (will it light up the road, or is it just a safety precaution?)
- Burn time of the battery (will it give you good light for your full ride?)
- Reliability (what experiences have others had with the system?)
- Warranty (how long will you be without your lights if they break?)
- Value (does it fit your budget?)

Over the years, we have found that several of the lighting systems on the market measure up in some or most of these qualities, but only one that meets all of them. The CYGOLITE's Night Explorer is the light that we have chosen to be our featured light system. It features:

- 20 Watts of halogen power (bright enough to see the road well)
- 2 beam patterns (10W wide, 10W narrow, 20W dual)
- Quick release mount (for quick removal & reinstallation)
- Weatherproof aluminum alloy casing (extremely durable)
- 2 1/2 hour battery burn time (1 1/4 at 20W)
- 1-year warranty on the lights, 3-month on the battery
- Reg. price of \$109.99 (compare to others at over \$200)

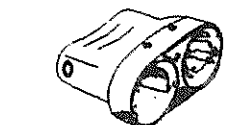

DUAL HEADLIGHT

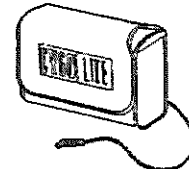

RECHARGEABLE 6VOLT BATTERY

One of our favorite features of this system is not something that one can not see immediately in the product. It's the quality of the product, & CYGOLITE's willingness to stand behind that product.

IF YOUR LIGHT FAILS UNDER WARRANTY, WHAT HAPPENS?

OTHER BRANDS-

Our policy, when possible, is to give the customer a new light if theirs fails under warranty, instead of sending it in for repair while the customer waits (sometimes a week or more). In the past, we have had a hard time with lighting companies standing behind their product, even on a very expensive light. We found a high number of failures in almost every brand that we carried, and no willingness on their part to send us a replacement light.



CYGOLITE-

We have sold CYGOLITE products for over two years now, and had the lowest failure rate that we have ever experienced in a lighting system. On the rare occasion that there is a warranty failure, the customer has left the store with a new part....no waiting, and CYGOLITE took care of sending us a new product pronto!



COME IN TO R+E CYCLES TODAY, AND SEE THE CYGOLITE NIGHT-EXPLORER! IT'S OUR FAVORITE LIGHT OF ALL TIME!

MEET THE QUEEN OF HEARTS!

**HOW TO BUY AND TRAIN WITH A HEART RATE MONITOR
SAT DEC 19 from 10 AM-noon**

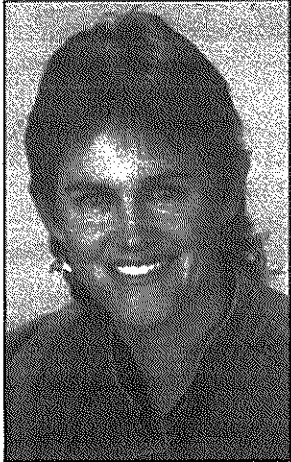

Sally Edwards the pioneer of heart zone training will be at R+E to answer all of your questions about how to select a heart rate monitor. She'll also teach you the basics of how to use it to train efficiently and intelligently.

Sally will be conducting a seminar at R+E CYCLES on SAT DEC 19 from 10 AM-noon. Seating is limited, on a first come, first served reservation basis. We'll be charging \$10 to hold you a spot. BUT, we'll also give you \$10 off when you purchase a heart rate monitor that day, or give you a \$10 autographed Sally Edwards' Heart Zone Wall Chart.

Refreshments and door prizes, too!!

To reserve your space please send us the following coupon to
R+E Cycles, 5627 University Way NE, Seattle WA, 98105



To sign up:

Name _____ phone(s) _____

Address _____ city, st. zip _____

Form of Payment:

Check enclosed Credit Card # _____ exp. _____

Type of card: Visa MC Discover

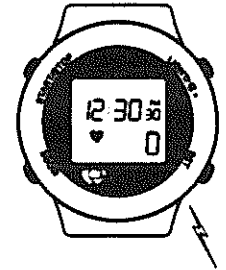

Bye Bye Cascade, Hello Bicycle Paper!

For the last 5 years, R+E Cycles has been donating a large space in our 'Cycleplex' to Cascade Cycling club to house their Activity Center. This year Cascade will be consolidating their operations, and moving the Activity Center to the Sandpoint area.

The space will now be occupied by the Bi-

cycle Paper. The Bicycle Paper has been serving the Northwest as the leading local cycling publication for 2 decades. We welcome them back to the University district! They will be moving into the space throughout the month of December, and open for business in January. If you're visiting the shop, make sure to wave at Paul and the others on your way through.

RE RAINY DAY COUPON!

Here's how it works! Bring in this coupon, and select the item you want. We'll take it outside on the sidewalk, and if it's raining hard enough to get the item wet, we'll give you 10% off. (up to \$100). Offer not good with any other offer. Excludes sale items.

Includes Bikes!

Offer good with coupon only. No cash value. Expires Jan. 10, 1999.

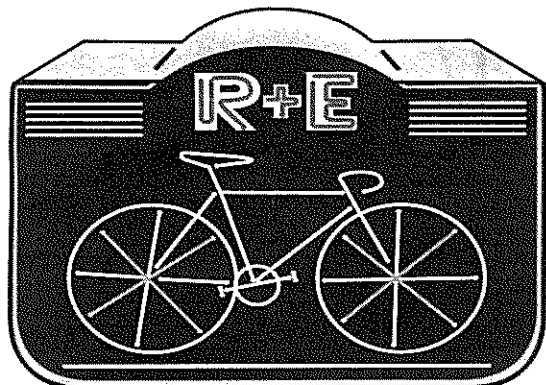

RE In The Zone!

Hurry, Limited supply!

Save big on this full featured heart rate monitor. The Autozone from Cardiosport features: Five heart rate zones • Heart zone hi/lo limit beeps • Out of zone alarm • Heart rate % of max • Bike mount included • And more!

Reg. \$150
Holiday Special \$129.99

Offer good with coupon only. No cash value. Expires Jan. 10, 1999.

RE FREE STUFF!??

The Sigma PC6 heart rate monitor includes all of the functions of a sports watch plus a heart rate reading and allows you to set a zone with an audible alarm. It also includes a handlebar mount. We are confident that its quality, and features for the dollar, can't be beat. Reg. \$100

Holiday Special \$89.99
and get the Heart Rate Monitor Book FREE! \$11 value

Offer good with coupon only. No cash value. Expires Jan. 10, 1999.

DON'T WANNA TRAIN IN THE RAIN?



How about riding in your living room instead?? You can get just as good a workout with an indoor trainer without the rain, darkness or traffic. For this winter, you might want to consider a stationary trainer or a classic set of rollers. What's the diff??

The CycleOps fluid trainer is a no brainer! You can easily mount your bike in the stand and pedal to your heart's max. This fluid trainer is the quietest on the market and it gives the best road-like feel. Unlike a traditional stationary bike you actually train on your own machine. When springtime comes around not only are you in top biking shape, your body is already comfortable with your cycling position. You can use any size or style bike with this trainer. It takes only 30 seconds to set up, or remove a bike, so you can share it with all your household members.

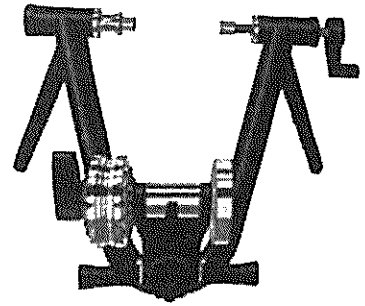

The CycleOps trainer also comes with a really cool 45 minute workout video. It is a fun way to work off those holiday calories.

Rollers give you a great workout and they also improve your cycling skills!

Rollers are not for everyone. They take some concentration but once you have mastered them you'll feel like a pro. We like the CycleOps rollers because they have lots of contact with the ground. If you have 15 minutes to kill, stop by and we'll teach you to ride them. It's that easy.

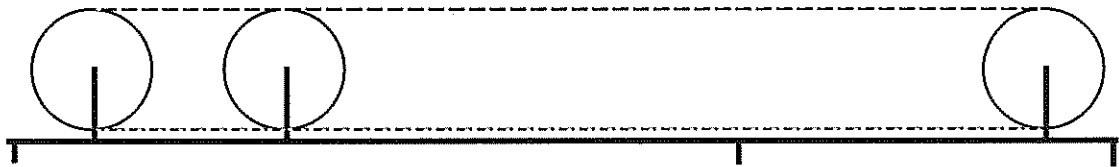

Cycleops Fluid Trainer: \$279.99

Cycleops Wind Trainer: \$169.99

Cycleops Rollers: \$254.99



RE Stay Dry This Winter!

Use this coupon to save 10% on any Cycleops trainer or rollers that we have in stock.

Limited to stock on hand
SAVE 10%

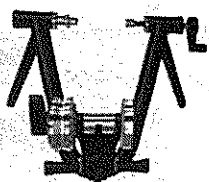

Offer good with coupon only. No cash value. Expires Jan. 10, 1999.

RE Make your own Coupon!

Use this coupon to save 10% (up to \$100) on anything in stock! Even bikes!

Offer not valid on sale priced merchandise
Not good with any other coupon

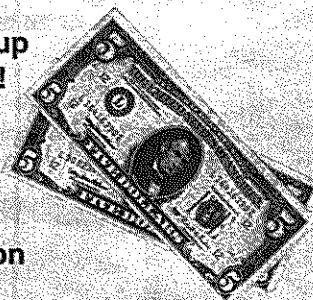

Offer good with coupon only. No cash value. Expires Jan. 10, 1999.



5627 University Way NE • Seattle • 206-527-4822



How to find us



5601 University Way NE Seattle
206-527-4310

